

# Accessories—Speed controllers

## NPSA, NPSS, PSA, PSS, PSL series



### Ordering code

#### NPSS 1/4 - 1/8 A

① ② ③ ④

##### ① Model

NPSS: Universal speed controller



##### ② Port size

5/32:  $\Phi 5/32"$   
 1/4:  $\Phi 1/4"$   
 5/16:  $\Phi 5/16"$   
 3/8:  $\Phi 3/8"$   
 1/2:  $\Phi 1/2"$

##### ③ Thread connection

Thread	Adaptable port size	
U10: #10-32UNF	$\Phi 5/32"$	
1/8: NPT1/8	$\Phi 1/4"$	$\Phi 5/16"$
1/4: NPT1/4	$\Phi 1/4"$	$\Phi 5/16"$
	$\Phi 3/8"$	
3/8: NPT3/8	$\Phi 3/8"$	$\Phi 1/2"$
1/2: NPT1/2	$\Phi 1/2"$	

##### ④ Control method

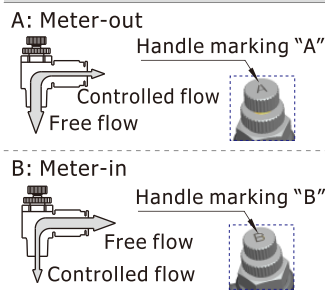

#### PSS 6 01 A

① ② ③ ④

##### ① Model

PSL: Speed controller



PSS: Universal speed controller



##### ② Port size

4:  $\Phi 4\text{mm}$   
 6:  $\Phi 6\text{mm}$   
 8:  $\Phi 8\text{mm}$   
 10:  $\Phi 10\text{mm}$   
 12:  $\Phi 12\text{mm}$

##### ③ Thread connection

Thread	Adaptable port size
M5: M5X0.8	$\Phi 4, \Phi 6$
01: PT1/8	$\Phi 4, \Phi 6$
02: PT1/4	$\Phi 8, \Phi 10$
03: PT3/8	$\Phi 12$
04: PT1/2	

##### ④ Control method

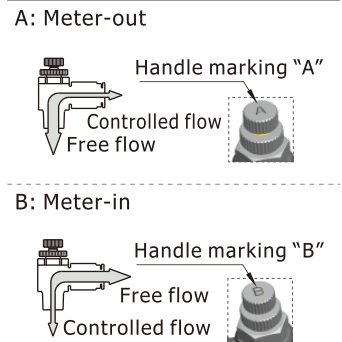

#### NPSA 1/4

① ②

##### ① Model

NPSA: Straight speed controller



##### ② Port size

5/32:  $\Phi 5/32"$   
 1/4:  $\Phi 1/4"$   
 5/16:  $\Phi 5/16"$   
 3/8:  $\Phi 3/8"$   
 1/2:  $\Phi 1/2"$

#### PSA 6

① ②

##### ① Model

PSA: Straight speed controller



##### ② Port size

4:  $\Phi 4\text{mm}$   
 6:  $\Phi 6\text{mm}$   
 8:  $\Phi 8\text{mm}$   
 10:  $\Phi 10\text{mm}$   
 12:  $\Phi 12\text{mm}$

### Table for interface port and tube O.D.

Product series	Thread type	Port size					Product series	Thread type	Port size					Product series	Thread type	Port size					
		$\Phi 5/32"$	$\Phi 1/4"$	$\Phi 5/16"$	$\Phi 3/8"$	$\Phi 1/2"$			$\Phi 4$	$\Phi 6$	$\Phi 8$	$\Phi 10$	$\Phi 12$			$\Phi 4$	$\Phi 6$	$\Phi 8$	$\Phi 10$	$\Phi 12$	
NPSS	#10-32UNF	●					PSS	M5	●					PSL	M5	●	●				
	NPT1/8		●	●				PT1/8		●	●					PT1/8	●	●	●		
	NPT1/4		●	●	●			PT1/4		●	●	●				PT1/4		●	●	●	
	NPT3/8				●			PT3/8				●	●			PT3/8		●	●	●	●
	NPT1/2					●		PT1/2					●			PT1/2			●	●	●
NPSA		●	●	●	●	●	PSA	-							●	●	●	●	●		

## NPSA, NPSS, PSA, PSS, PSL series

### Product feature

1. The silencer is small size, and light weight with small installation space.
2. Excellent flow characteristics, high sensitivity and easy to adjust.
3. The silencer brass body adopts a special nickel-plating process, which has good corrosion resistance and anti-pollution property.
4. Anti-drop structure is designed on the regulating rod.
5. The sealant being coated on threaded portion can ensure no leakage of the threaded connection part.
6. The inserting direction of universal speed controller can be adjusted in 360°.

### Specification

<b>Operating pressure range</b>	<b>0~145psi(0~1.0MPa)</b>
Negative pressure	10Torr(-750mmHg)
Proof pressure	215psi(1.5MPa)
Ambient and fluid temperature	-5~160°F (-20~70°C)
Applicable tubing	Soft nylon or polyurethane

### Inner structure

#### NPSA, PSA Series

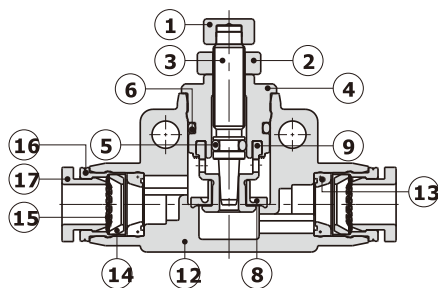

#### NPSS, PSS Series

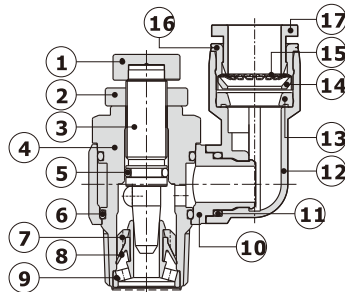

#### PSL Series

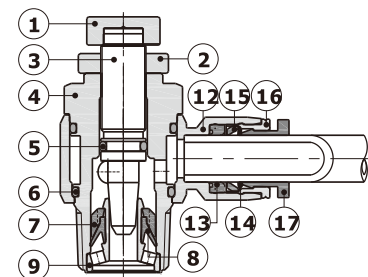

NO.	Name	NO.	Name	NO.	Name	NO.	Name	NO.	Name	NO.	Name
1	Adjusting cap	4	Throttling body	7	Holder	10	Plastic body	13	O-ring	16	Locating ring
2	Locking cap	5	O-ring	8	O-ring	11	O-ring	14	Locating seat	17	Plastic interface
3	Throttling column	6	O-ring	9	Throttling sleeve	12	Plastic body	15	Spring gasket		

### Dimensions

#### PSL Series

[Unit: mm]

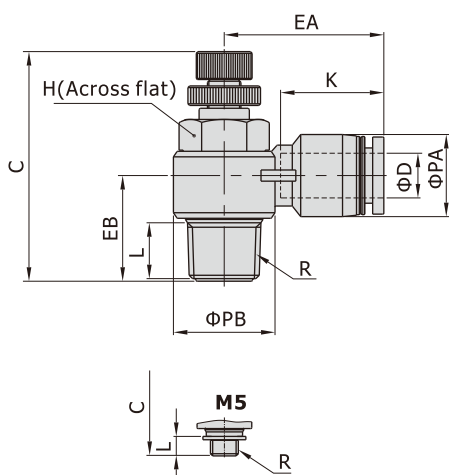

Model\Item [Note1]	ΦD	R	ΦPA	ΦPB	L	C		K	EA	EB	H	Weight (g)
						max	min					
PSL4M5□	4	M5×0.8	9	10	3.5	30	27.5	14	19	9.5	8	6.5
PSL401□		PT1/8	9	14	7.5	41.5	35	14	20.5	15	11	16.5
PSL6M5□	6	M5×0.8	12.5	10	3.5	30	27.5	16.5	23.5	11.5	8	8
PSL601□		PT1/8	12.5	14	7.5	41.5	35	16.5	23	15.5	11	17.5
PSL602□		PT1/4	12.5	18	10	47.5	41	16.5	25	18	14	32
PSL603□	8	PT3/8	12.5	22.5	11	52.5	45.5	16.5	27	20	19	59.5
PSL801□		PT1/8	15	14	7.5	41.5	35	18.5	26.5	16.5	11	18
PSL802□		PT1/4	15	18	10	47.5	41	18.5	28.5	19	14	33
PSL803□		PT3/8	15	22.5	11	52.5	45.5	18.5	29.5	20	19	60
PSL804□	10	PT1/2	15	28	14	58.5	51.5	18.5	32	25	24	96.5
PSL1002□		PT1/4	18	18	10	47.5	41	21	31	20.5	14	34.5
PSL1003□	12	PT3/8	18	22.5	11	52.5	45.5	21	33	21.5	19	62
PSL1004□		PT1/2	18	28	14	58.5	51.5	21	35.5	25.5	24	98
PSL1203□	12	PT3/8	21	22.5	11	52.5	45.5	23	36	23.5	19	64
PSL1204□		PT1/2	21	28	14	58.5	51.5	23	38	27	24	100

[Note1] "□" stands for A or B. A indicates meter-out type while B indicates meter-in type. The two types are with the same overall dimension.

## NPSA, NPSS, PSA, PSS, PSL series

### NPSS Series

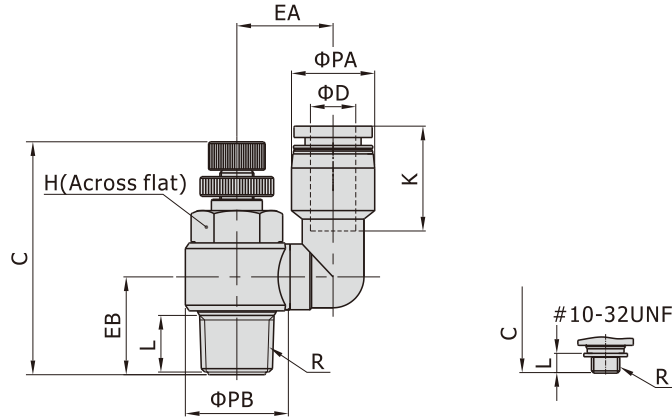

[Unit: inch]

Model\Item	ΦD	R	ΦPA	ΦPB	L	C		K	EA	EB	H	Weight (g)
						max	min					
NPSS5/32-U10□	5/32	#10-32UNF	0.35	0.39	0.14	1.18	1.08	0.52	0.49	0.37	5/16	8.1
NPSS1/4-1/8□	1/4	NPT1/8	0.49	0.55	0.30	1.63	1.38	0.67	0.67	0.59	7/16	19.0
NPSS1/4-1/4□		NPT1/4	0.49	0.71	0.39	1.87	1.61	0.67	0.75	0.69	9/16	35.0
NPSS5/16-1/8□	5/16	NPT1/8	0.59	0.55	0.30	1.63	1.38	0.73	0.67	0.59	7/16	20.2
NPSS5/16-1/4□		NPT1/4	0.59	0.71	0.39	1.87	1.61	0.73	0.75	0.69	9/16	40.1
NPSS3/8-1/4□	3/8	NPT1/4	0.71	0.71	0.39	1.87	1.61	0.83	0.81	0.69	9/16	37.5
NPSS3/8-3/8□		NPT3/8	0.71	0.89	0.43	2.07	1.79	0.83	0.94	0.79	3/4	66.0
NPSS1/2-3/8□	1/2	NPT3/8	0.83	0.89	0.43	2.07	1.79	0.91	1.02	0.79	3/4	69.2
NPSS1/2-1/2□		NPT1/2	0.83	1.10	0.55	2.30	2.03	0.91	1.10	0.98	15/16	105.4

### PSS Series

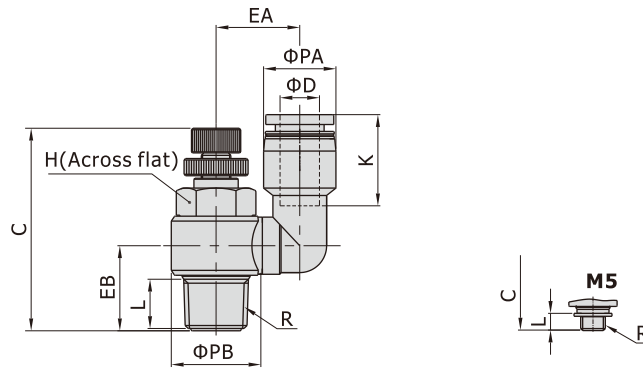

[Unit: mm]

Model\Item [Note1]	ΦD	R	ΦPA	ΦPB	L	C		K	EA	EB	H	Weight (g)
						max	min					
PSS4M5□	4	M5×0.8	9	10	3.5	30	27.5	14	12.5	9.5	8	8.1
PSS601□	6	PT1/8	12.5	14	7.5	41.5	35	17	17	15	11	19
PSS602□		PT1/4	12.5	18	10	47.5	41	17	19	17.5	14	34.7
PSS801□	8	PT1/8	15	14	7.5	41.5	35	18.5	17	15	11	20.2
PSS802□		PT1/4	15	18	10	47.5	41	18.5	19	17.5	14	39.8
PSS1002□	10	PT1/4	18	18	10	47.5	41	21	20.5	17.5	14	37.2
PSS1003□		PT3/8	18	22.5	11	52.5	45.5	21	24	20	19	66
PSS1203□	12	PT3/8	21	22.5	11	52.5	45.5	23	25.5	20	19	69.2
PSS1204□		PT1/2	21	28	14	58.5	51.5	23	28	25	24	105.8

[Note1] "□" stands for A or B. A indicates meter-out type while B indicates meter-in type.  
The two types are with the same overall dimension.

# Accessories—Speed controllers

## NPSA, NPSS, PSA, PSS, PSL series

### NPSA Series

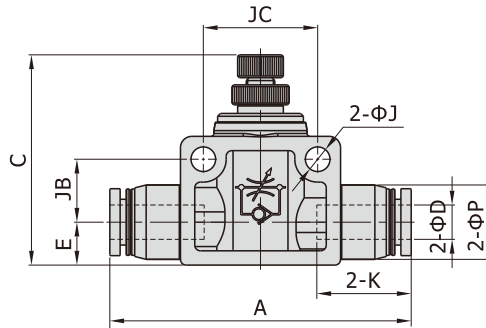

[Unit: inch]

Model\Item	ΦD	A	B	C		ΦP	E	K	ΦJ	JB	JC	Weight (g)
				max	min							
NPSA5/32	5/32	1.55	0.43	1.14	1.04	0.37	0.28	0.52	0.13	0.24	0.55	7.85
NPSA1/4	1/4	2.07	0.65	1.71	1.44	0.51	0.30	0.65	0.17	0.43	0.79	18.3
NPSA5/16	5/16	2.34	0.65	1.85	1.57	0.59	0.33	0.73	0.17	0.43	0.87	23.5
NPSA3/8	3/8	2.72	0.83	2.11	1.83	0.71	0.41	0.83	0.17	0.57	1.02	42.4
NPSA1/2	1/2	3.09	1.02	2.30	2.01	0.85	0.47	0.91	0.17	0.69	1.26	67.5

### PSA Series

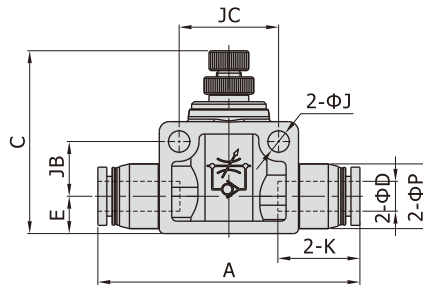
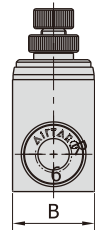

[Unit: mm]

Model\Item	ΦD	A	B	C		ΦP	E	K	ΦJ	JB	JC	Weight(g)
				max	min							
PSA4	4	41	11	29	26.5	9.5	7	14	3.2	6	14	7.85
PSA6	6	52.5	16.5	43.5	36.5	13	7.5	16.5	4.3	11	20	18.3
PSA8	8	59.5	16.5	47	40	15	8.5	18.5	4.3	11	22	23.5
PSA10	10	69	21	53.5	46.5	18	10.5	21	4.3	14.5	26	42.4
PSA12	12	78.5	26	58.5	51	21.5	12	23	4.3	17.5	32	67.5

## NPSA, NPSS, PSA, PSS, PSL series

### Flowrate characteristic

#### Controlled flow rate

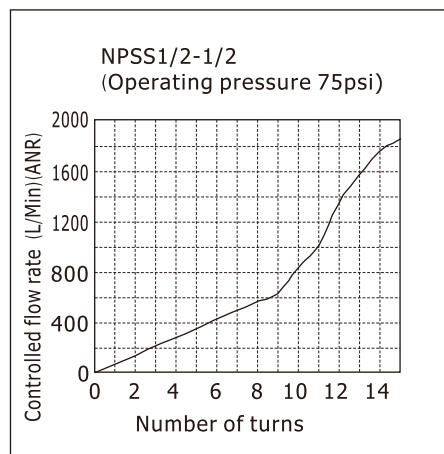
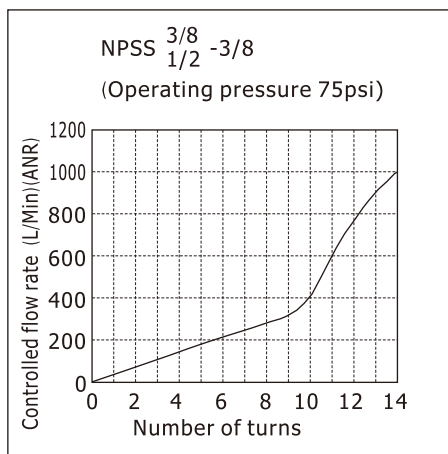
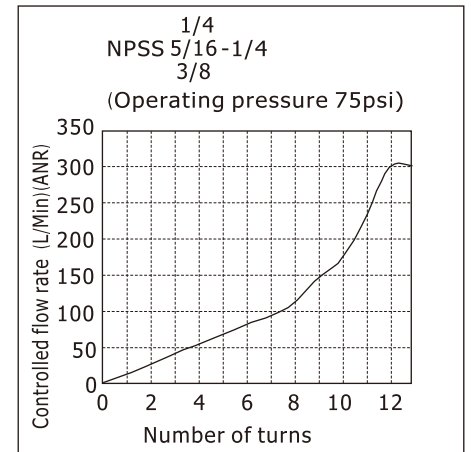
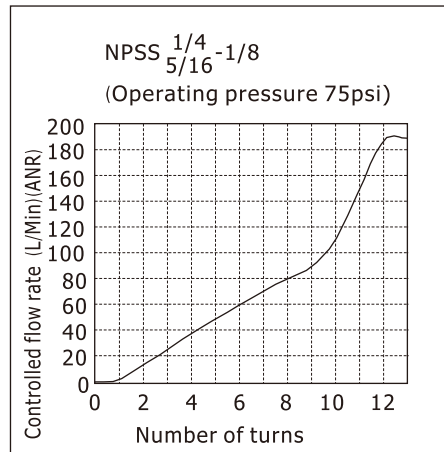
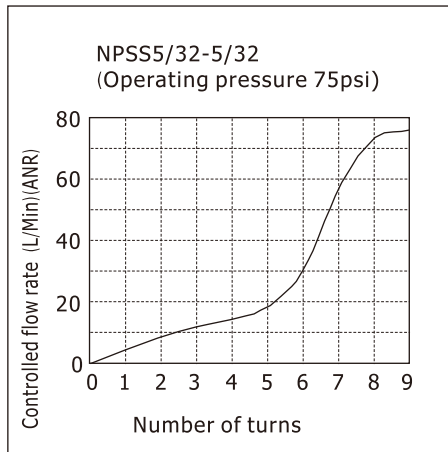
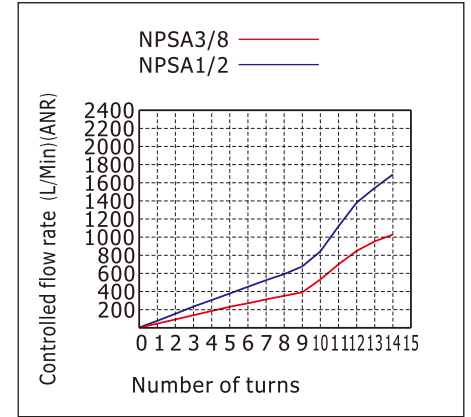
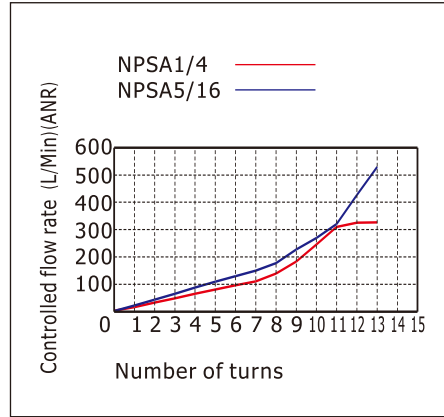
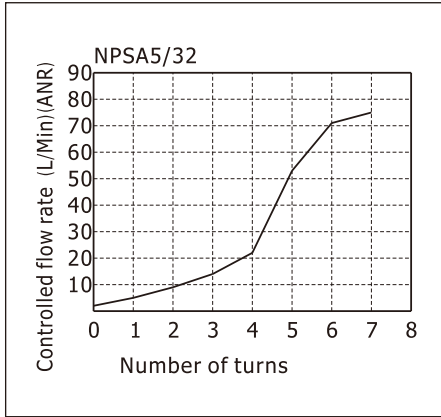

## NPSA, NPSS, PSA, PSS, PSL series

### Free flow rate

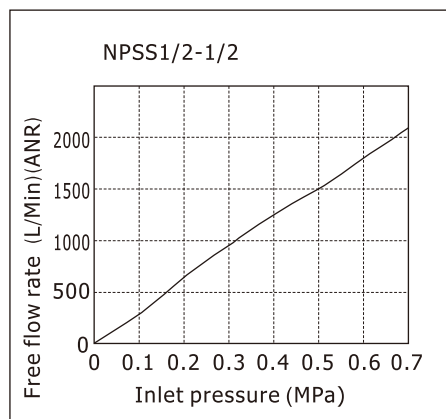
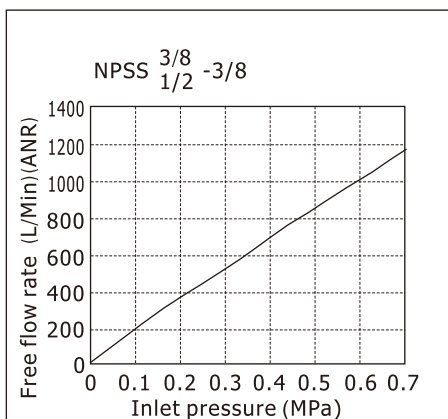
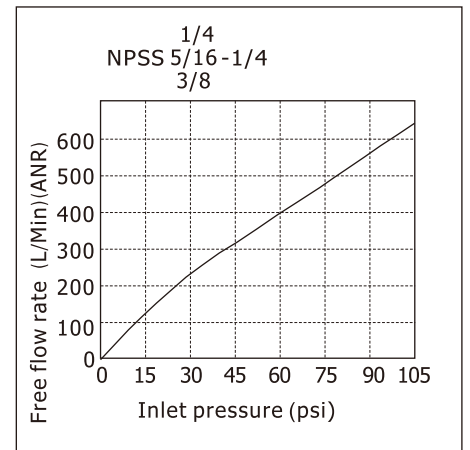
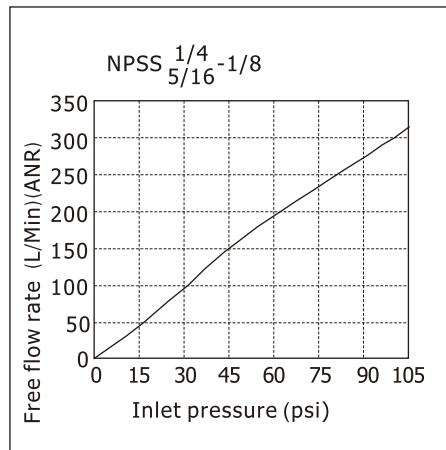
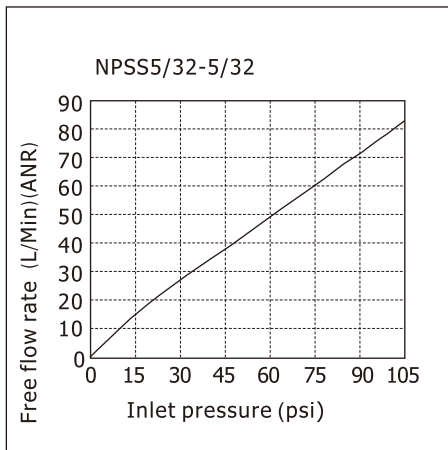
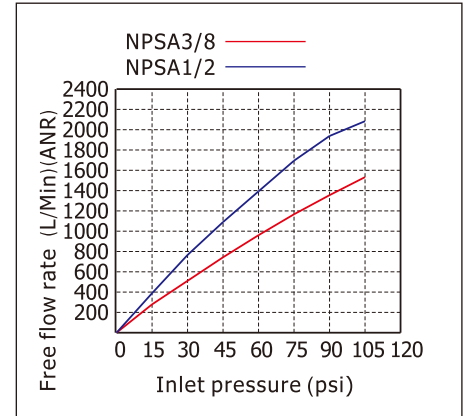
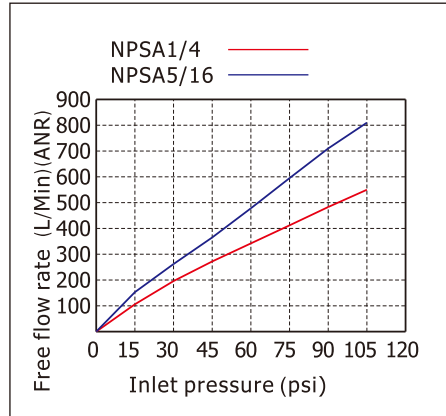
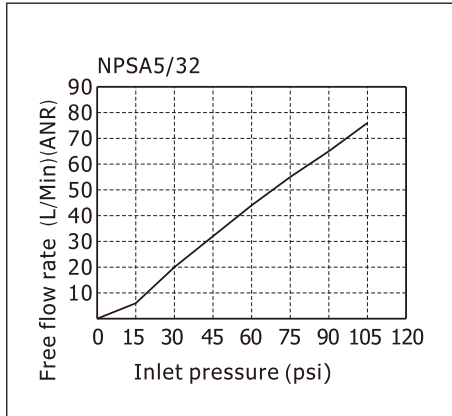

## NPSA, NPSS, PSA, PSS, PSL series

### Flowrate characteristic

#### Controlled flow rate

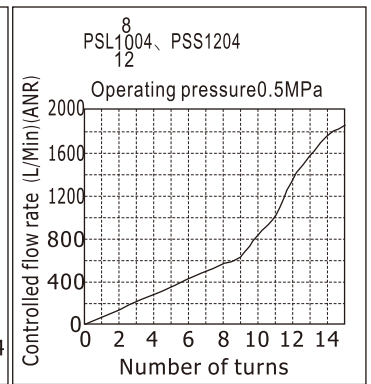
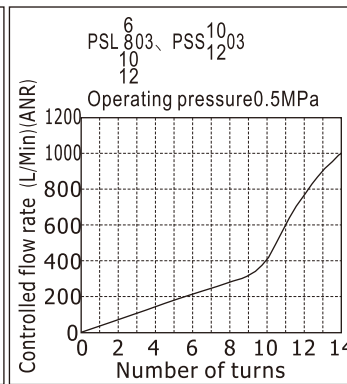
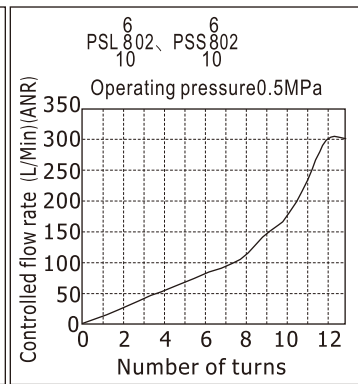
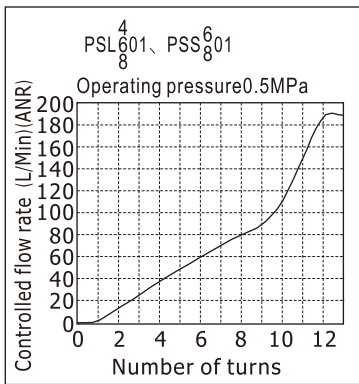
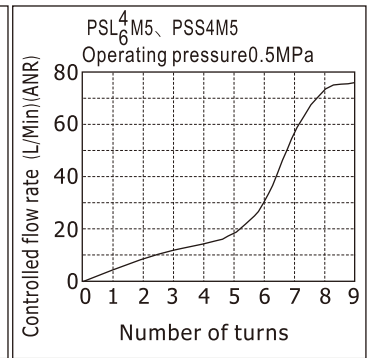
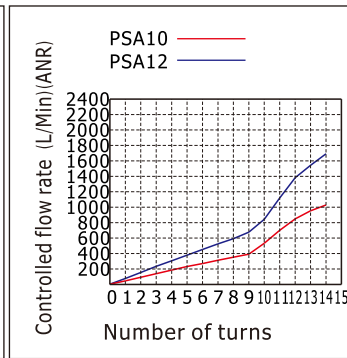
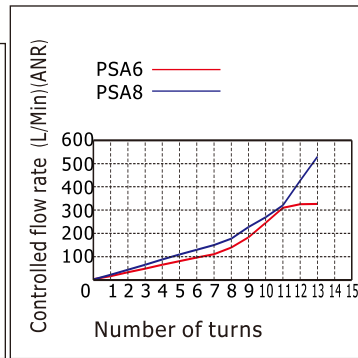
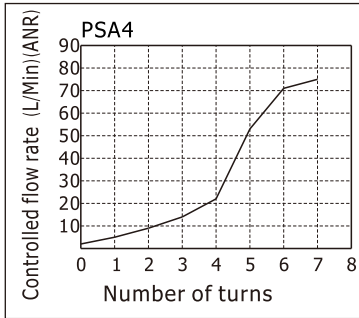

#### Free flow rate

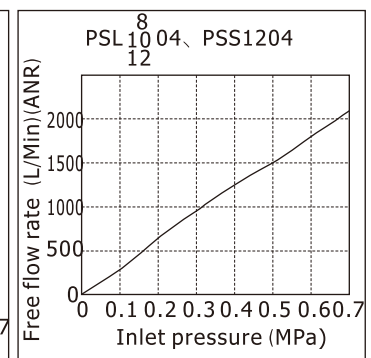
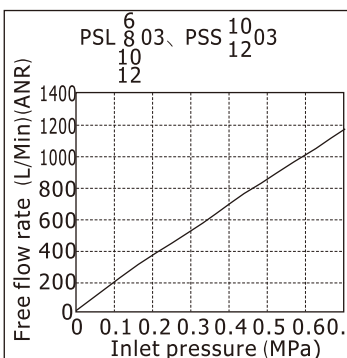
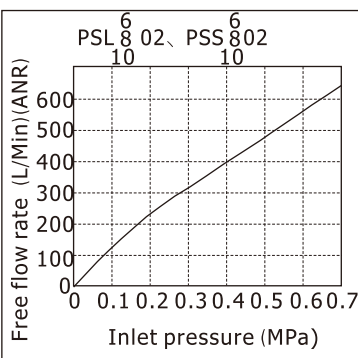
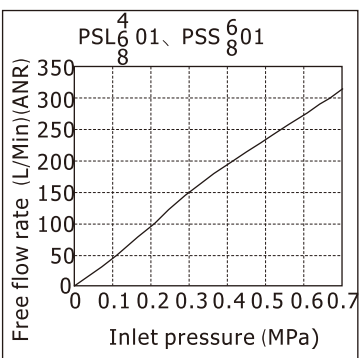
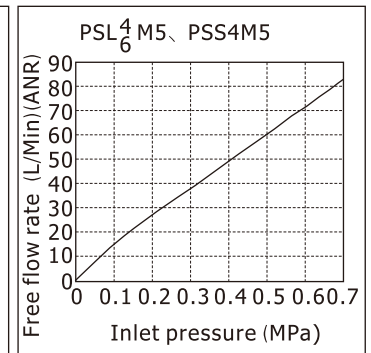
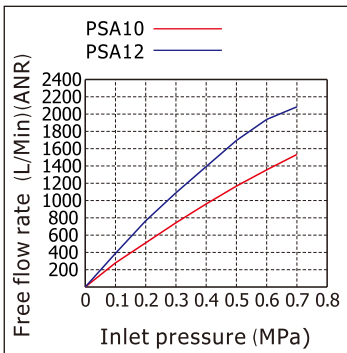
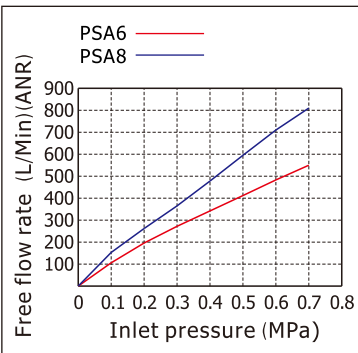
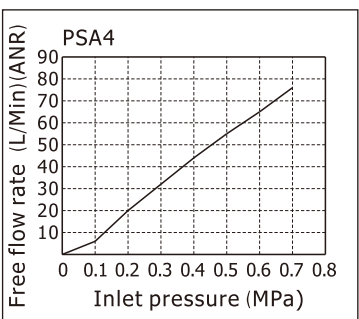

## NPSA, NPSS, PSA, PSS, PSL series

### Selection, Installation and Operation

#### Selection

1. The speed controller has meter-out type and meter-in type:

	Working principle	Product identification
<p>Controlled flow Free flow</p>	<p>A: Meter-out</p> <ol style="list-style-type: none"> <li>The air flow is controlled from the threaded end to tubing connection end.</li> <li>The air flow is free from the tubing connection end to the threaded end.</li> </ol>	<p>Handle marking "A"</p>
<p>Free flow Controlled flow</p>	<p>B: Meter-in</p> <ol style="list-style-type: none"> <li>The air flow is free from the threaded end to tubing connection end.</li> <li>The air flow is controlled from the tubing connection end to the threaded end</li> </ol>	<p>Handle marking "B"</p>

2. Select the different control method according to the actual requirement. The meter-out type is the first priority.

2.1. The application example of the meter-out speed controller	2.2. The application example of the meter-in speed controller
<p>Solenoid valve      Double acting cylinder</p> <p>Meter-out speed controller</p>	<p>Solenoid valve      Single acting cylinder</p> <p>Meter-in speed controller</p>

#### Installation

1. Installation and removal of tubing:

1.1. Installation of tubing

Grasp the tubing and slowly push it into the fitting until it comes to a stop. The tubing will be locked by the spring gasket.

1.2. Removal of tubing

Push the release button to open the spring gasket so that the tubing can be released.

Note: When remove the tubing, make sure the pressure in the tubing is Zero.

2. Mounting of the speed controller

Mount the speed controller into the inlet and outlet port of the cylinder with a wrench.

Note: Please refer to the fittings for the tightening torque and thread screw-in depth.

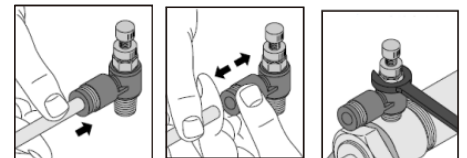

#### Operation

1. Adjustment of the cylinder speed

1.1. Make sure the speed controller is turned off before applying air pressure. The cylinder may fly out due to the high speed if the air is inlet when the speed controller is turned on.

1.2. Adjust the speed by opening the needle slowly from the fully closed state. When a needle valve is turned clockwise, the air flow through is reduced and the actuator speed decreases. When a needle valve is turned counter-clockwise, the air flow through is increased and the actuator speed increases.

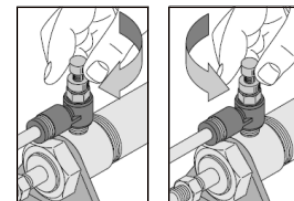

2. Operation of the speed controller

2.1. Do not use tools such as pliers to rotate the handle. Do not apply excessive force or shock when the needle is at the place of top or bottom. It can cause damage or air leakage.

2.2. A certain amount of leakage is allowed in the closed state of the speed controller. It is not designed for the use as stop valve with zero air leakage.